

# RI/RO-50S

## Style by Oil Plug Machining Position

Style A	Style B	Style C
		
Style D	Style E	Style F
		

Additional Information	
Filler, Drain (black circle)	Rc1/4
Level (white circle)	Φ20
Rough Product Weight	10kg
Rough Lubricating Oil Capacity	0.6 Liters
Mounting Tapped Holes	Pre-machined at all 6 faces

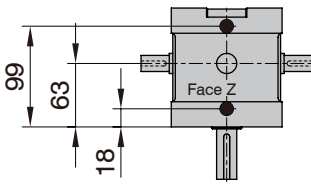
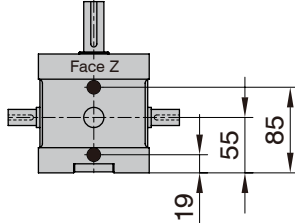
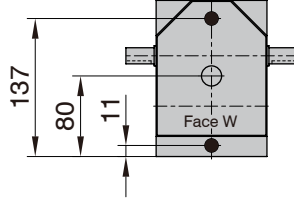
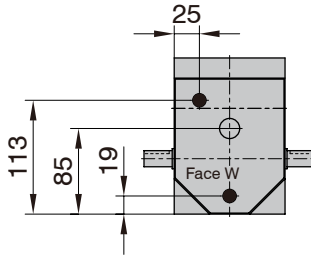
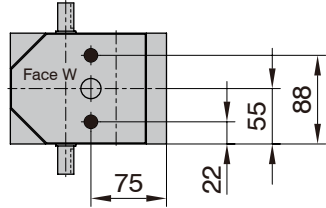
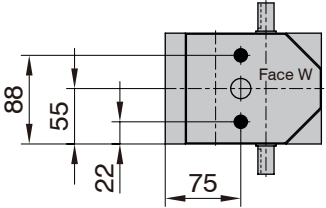
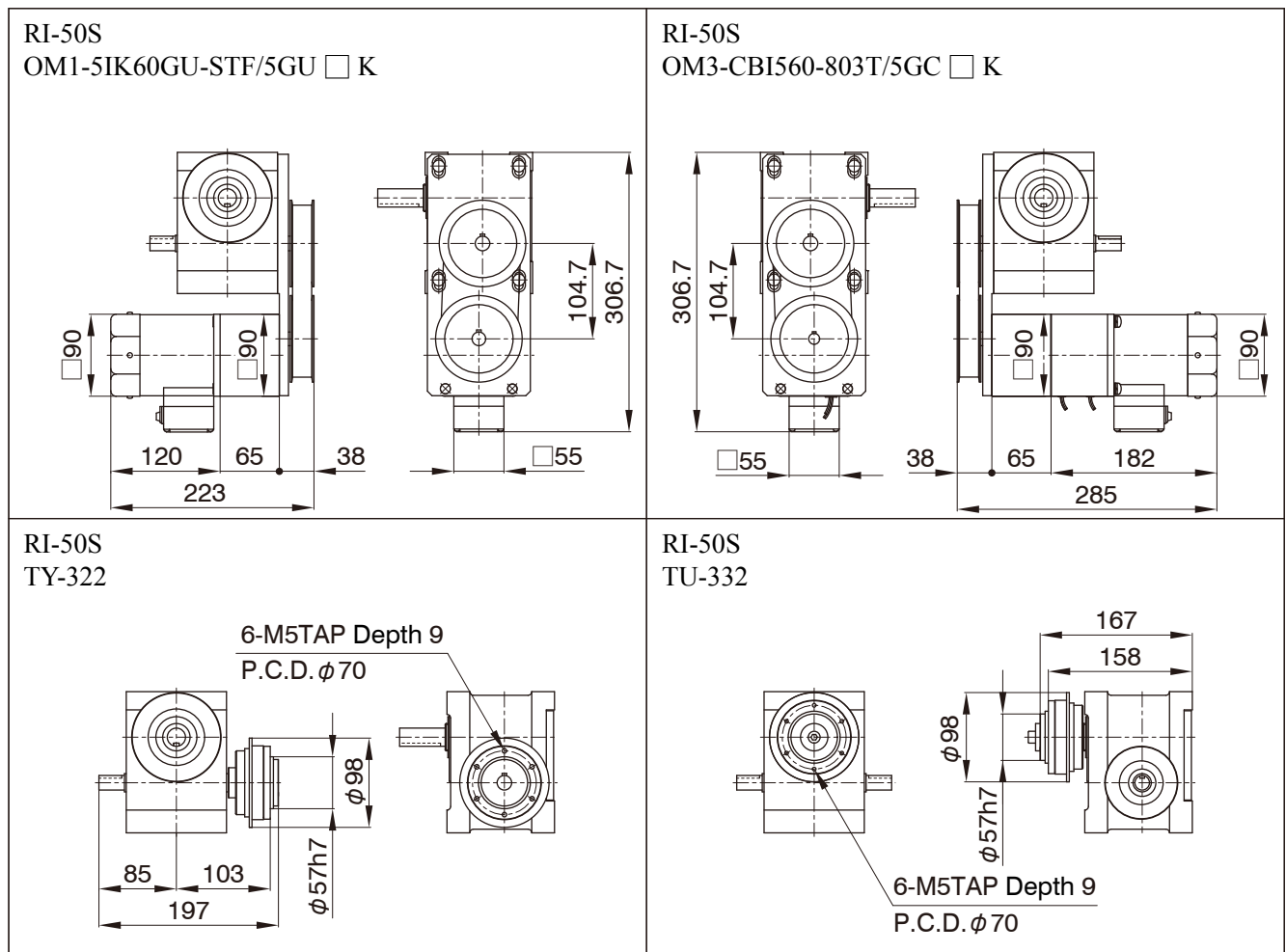

### Additional Notes

- Various types of an AC standard small-sized motor can be mounted.
- Mounting positions of an AC standard small-sized motor is standardized as 4 different patterns.
- MYTORQ torque limiter 300 series can be mounted.
- Autoflex couplings can be mounted.
- Autogard torque limiter 400 series or Autoflex couplings can be mounted on the input shafts of a worm reducer.